

Conference Center 7

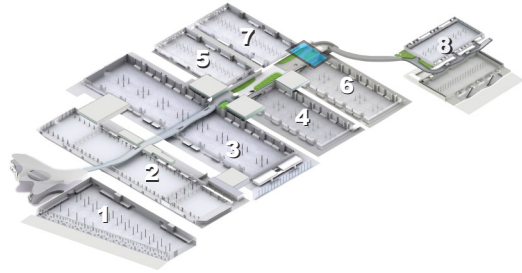

ROOM 7.8, 7.9 and 7.10
16 pax + 16 pax + 14 pax

ROOM 7.6 and 7.7
8 pax each

ROOM 7.4 and 7.5
16 pax each

Soundproof doors and walls
The rooms can be merged opening the airwalls

ROOM 7.12 and 7.13
14 pax each

ROOM 7.11 and 7.14
16 pax each

ROOM 7.2 and 7.3
16 pax each

The rooms can be merged opening the airwalls

ROOM 7.15
16 pax

ROOM 7.1
54 pax each (A, B or C)
203 pax (A+ B+C)
Soundproof doors and walls
The room can be divided using airwalls

| Room | sqm | pax | default format | height |
|-----------|----------|----------|----------------|--------|
| 7.1 | 253 | 222 | theatre | 4,47m |
| A, B or C | 81/91/81 | 77/80/74 | | |
| 7.2 | 37 | 16 | boardroom | 3 m |
| 7.3 | 37 | 16 | | |
| 7.4 | 40 | 16 | | |
| 7.5 | 40 | 16 | | |
| 7.6 | 13 | 8 | | |
| 7.7 | 13 | 8 | | |
| 7.8 | 26 | 16 | | |
| 7.9 | 26 | 16 | | |
| 7.10 | 21 | 14 | | |
| 7.11 | 38 | 16 | | |
| 7.12 | 24 | 14 | | |
| 7.13 | 24 | 14 | | |
| 7.14 | 38 | 16 | | |
| 7.15 | 35 | 16 | | |

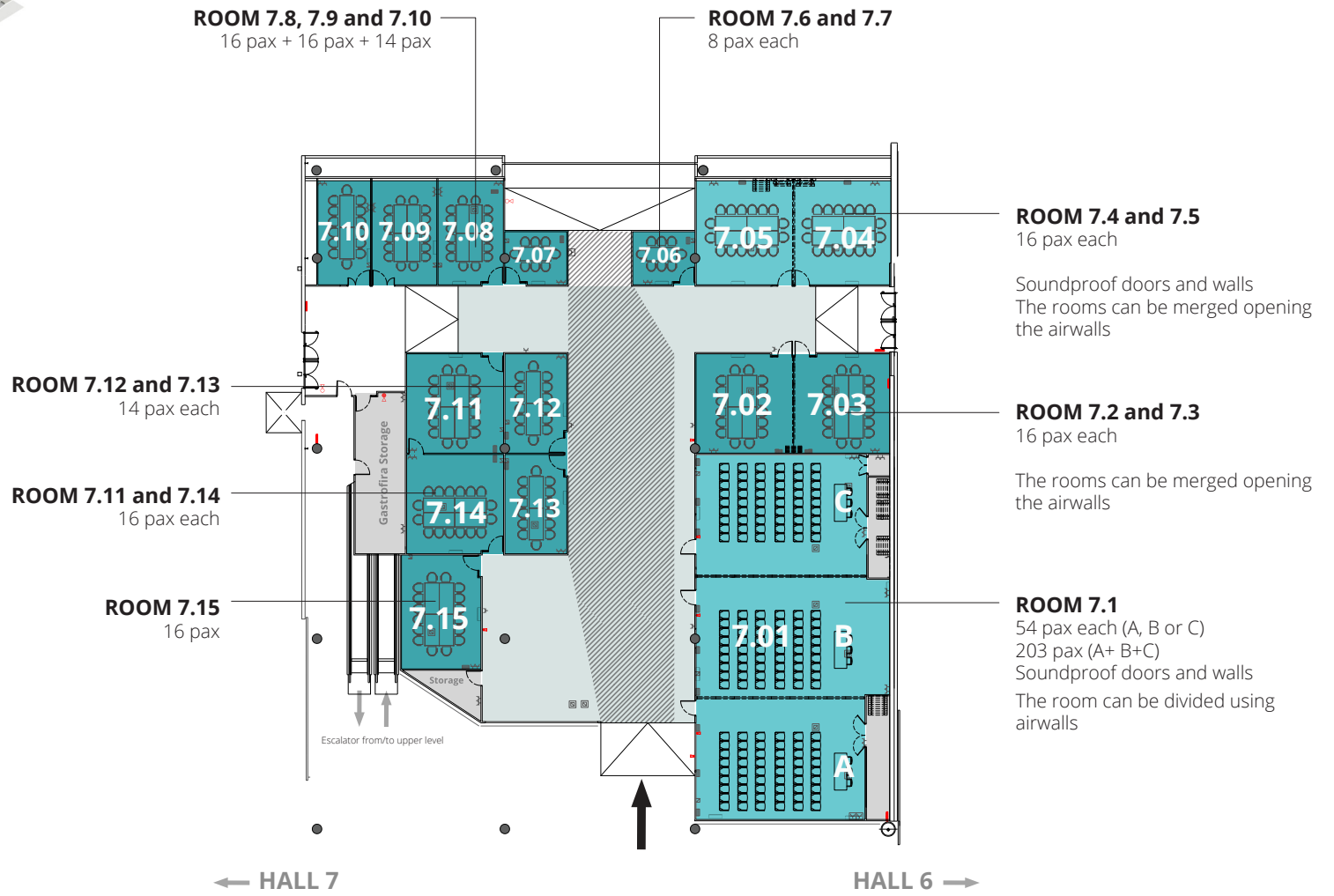

- raised floor 20cm high
neither palette jack nor lift trucks allowed
- escape route
(to be left free of objects)







Room 7.1 A, B, C



253 sqm (81 + 91 + 81sqm)

Room height: 4.47 m

Soundproof doors and walls
The room can be divided with airwalls

-  Emergency exit
-  Fire extinguisher
-  Built-in floor box
-  4 X wall sockets
-  Power socket
-  Air conditioning unit
-  Ventilation grill

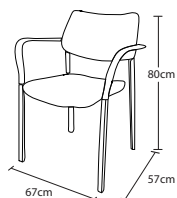



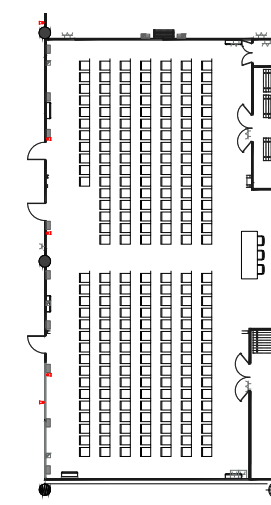
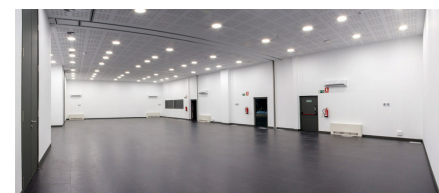
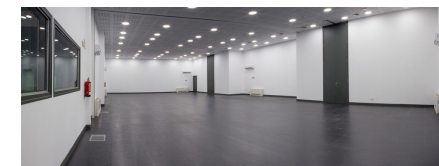
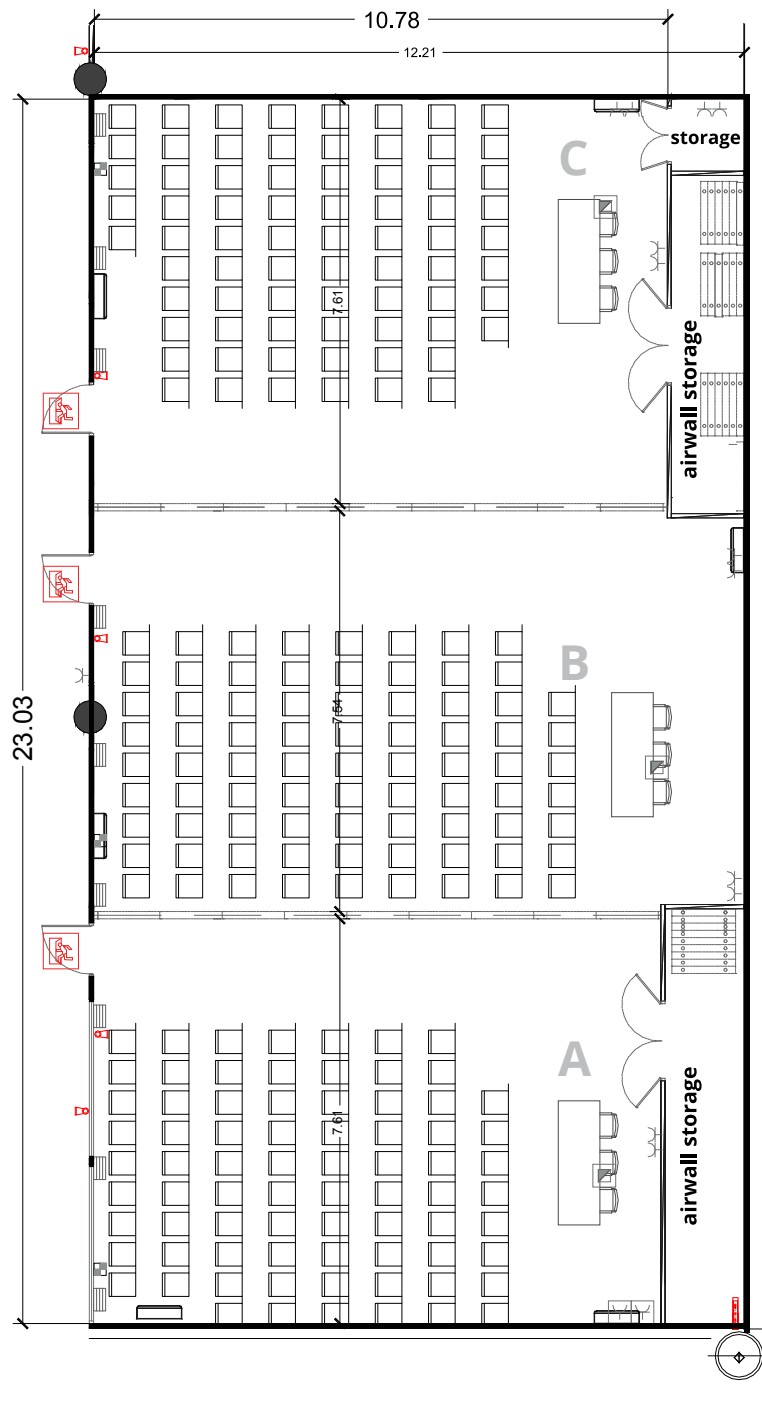

There are two soundproof windows in this room
Dimensions: 1.92m X 0.88m each



Option with no partitions

ROOM CAPACITIES



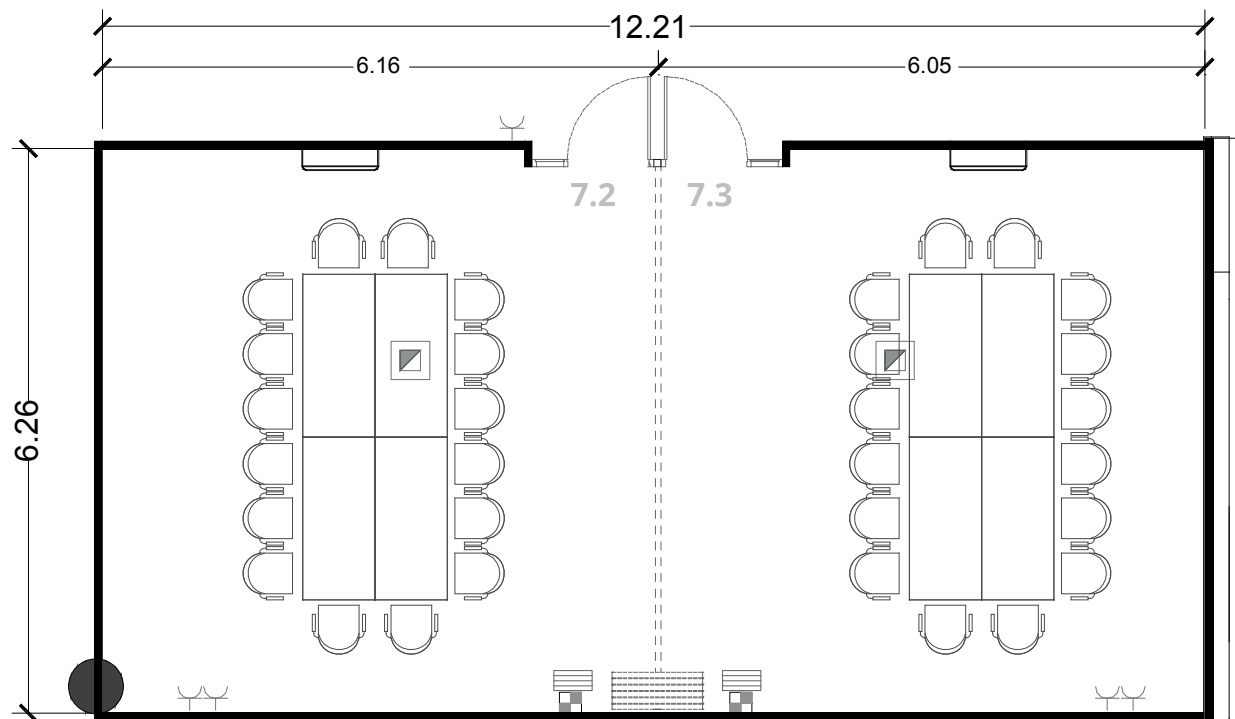
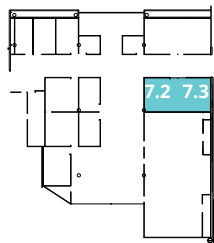

| |  |  |  |  |
|------------|---|---|---|---|
| | Theatre | Classroom* | U shape* | Boardroom* |
| 7.1 | 222 | 120 | 63 | 72 |
| A | 77 | 30 | 21 | 24 |
| B | 80 | 36 | 27 | 30 |
| C | 74 | 30 | 21 | 24 |

* using 200 X 80cm tables for 3 pax each





Rooms 7.2 and 7.3



74 sqm (37+ 37sqm)
Room height: 3.00 m

-  Built-in floor box
-  4 X wall sockets
-  Power socket
-  Air conditioning unit
-  Ventilation grill

ROOM CAPACITIES

| |  |  |  |  |
|------------|---|---|---|---|
| | Theatre | Classroom | U shape | Boardroom |
| 7.2 or 7.3 | 20/21 | 16 | 12 | 16 |
| 7.2 + 7.3 | 67 | 36 | 27 | 30 |

The default format is boardroom

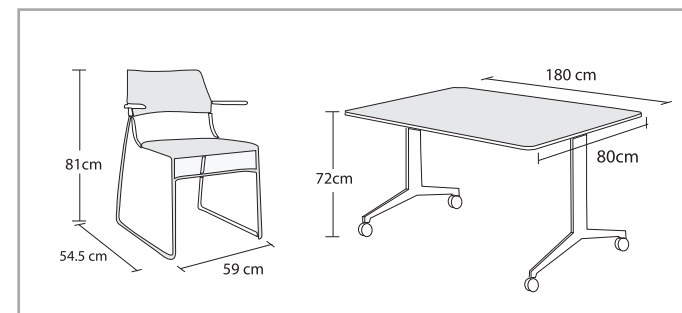

Rooms 7.4 and 7.5









80 sqm (40 + 40sqm)





Room height: 3.00 m

Soundproof doors and walls

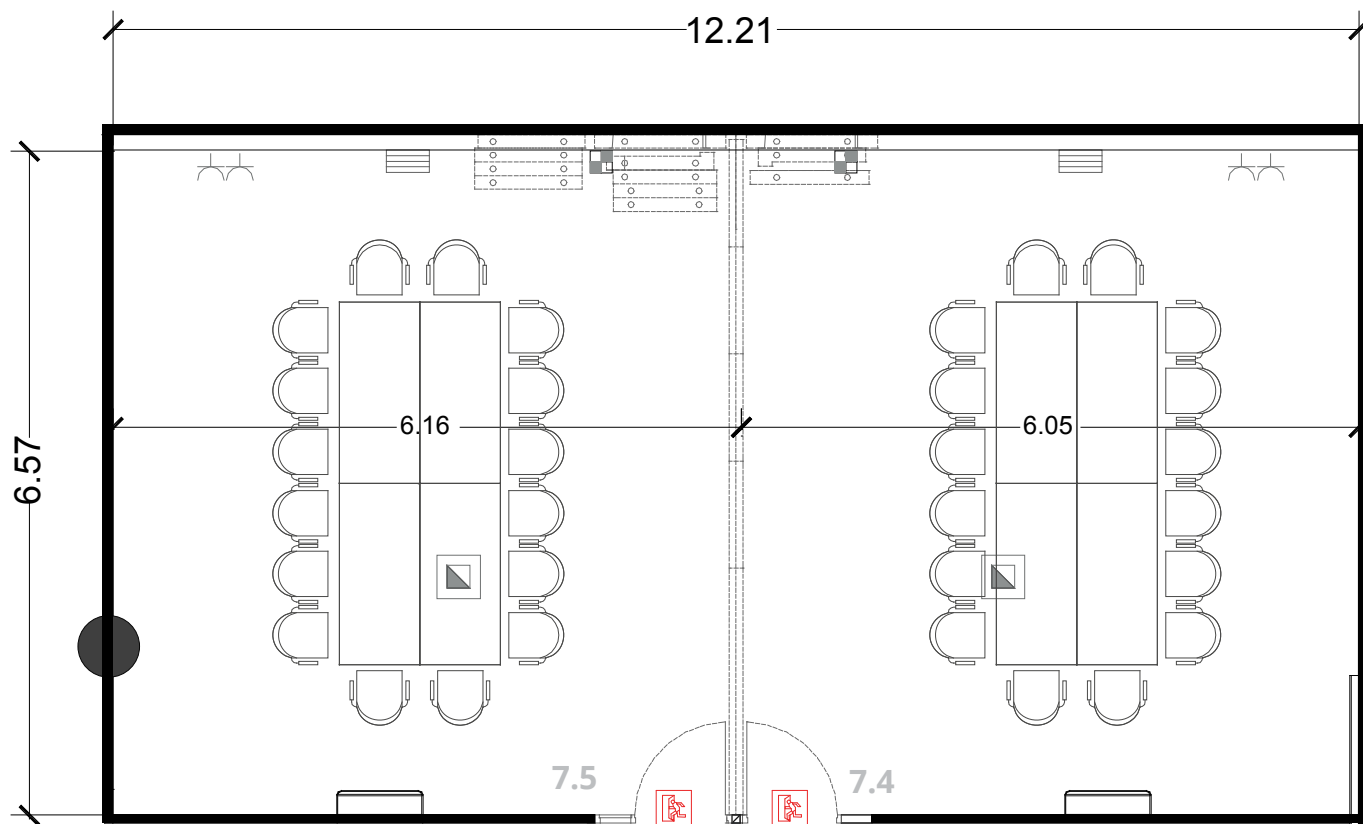
The room can be divided with airwalls

-  Emergency exit
-  Built-in floor box
-  4 X wall sockets
-  Power socket
-  Air conditioning unit
-  Ventilation grill



| ROOM CAPACITIES | | | | |
|-----------------|---|---|---|---|
| |  |  |  |  |
| | Theatre | Classroom | U shape | Boardroom |
| 7.4 or 7.5 | 25 | 12 | 14 | 16 |
| 7.4 + 7.5 | 67 | 36 | 27 | 30 |

The default format is boardroom

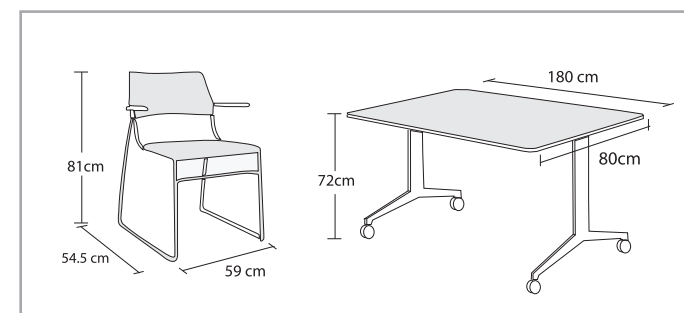



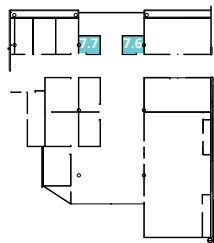

Rooms 7.6 and 7.7

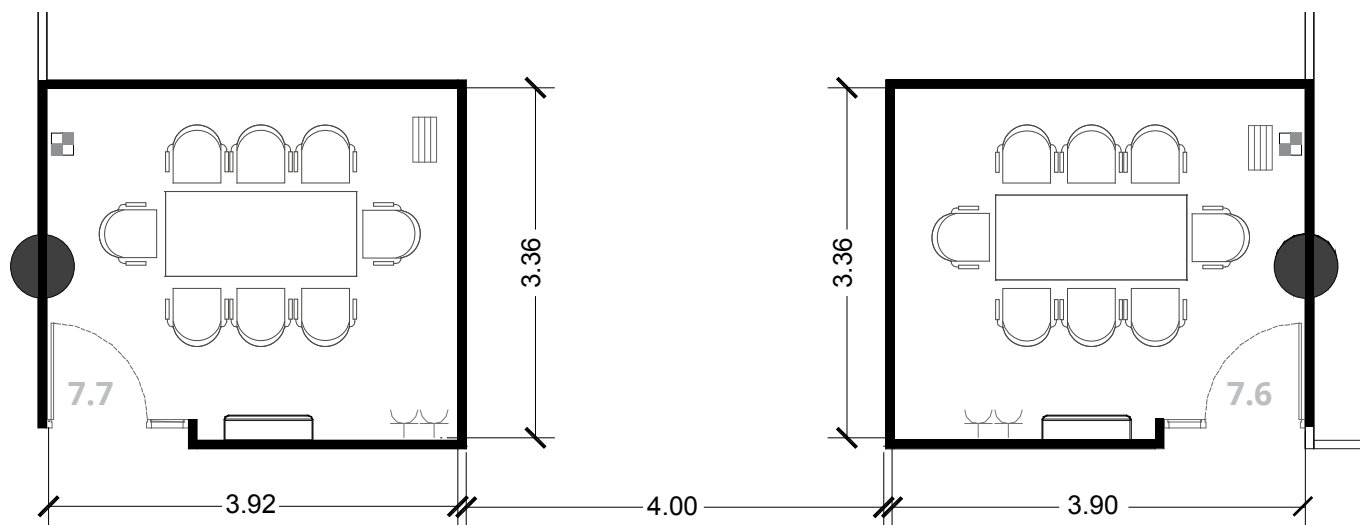

13 sqm each
Room height: 3.00 m



-  Built-in floor box
-  4 X wall sockets
-  Power socket
-  Air conditioning unit
-  Ventilation grill



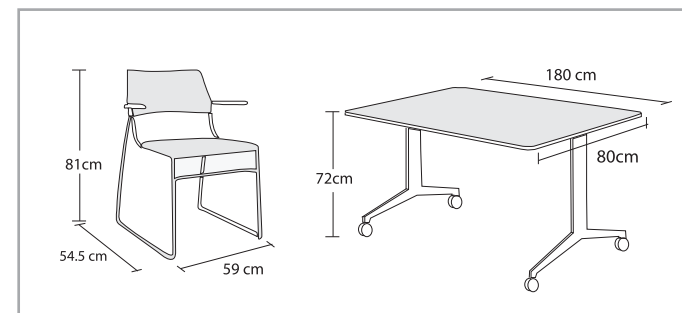

Room capacity: 8 pax each

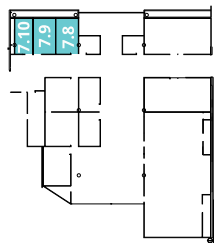

Rooms 7.8, 7.9 and 7.10



26 sqm/ 26sqm and 21sqm
 Room height: 3.00 m
 Capacity: 16 pax/ 16 pax / 14 pax

-  Built-in floor box
-  4 X wall sockets
-  Power socket
-  Air conditioning unit
-  Ventilation grill

Room capacity: 16 / 16 / 14 pax

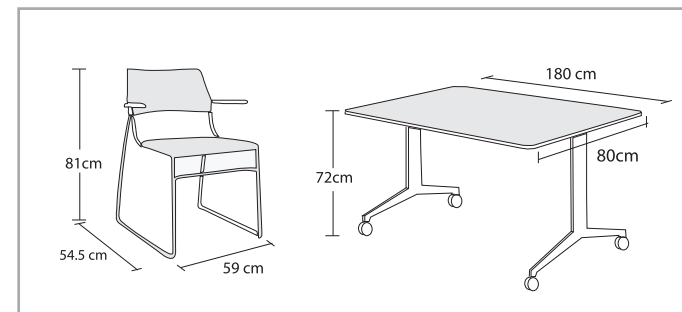
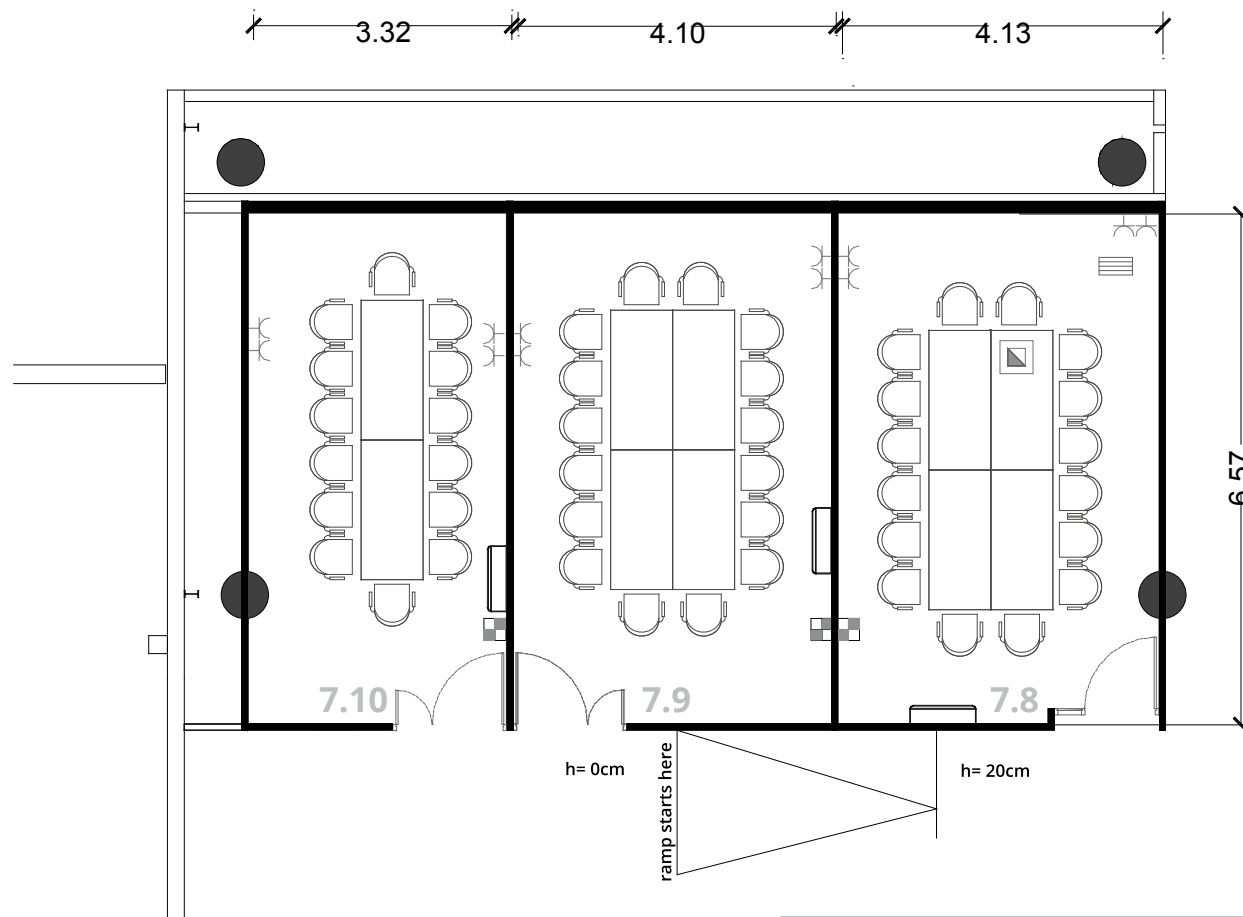





Room 7.11 and 7.14



38 sqm each

Room height: 3.00 m

Both rooms are connected through a lockable door

-  Built-in floor box
-  4 X wall sockets
-  Power socket
-  Air conditioning unit
-  Ventilation grill

Room capacity: 16 pax each

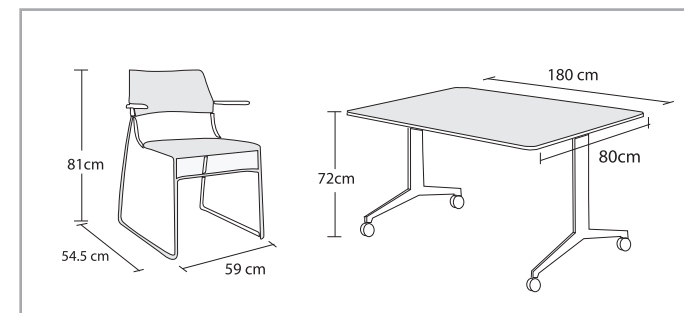
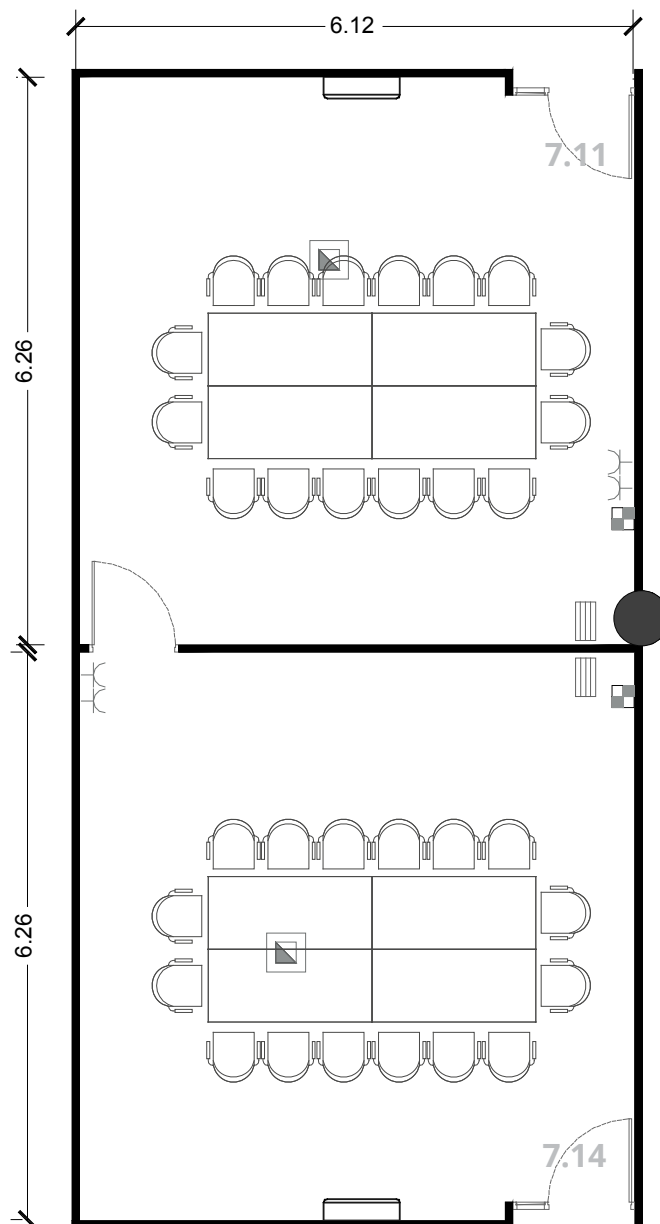



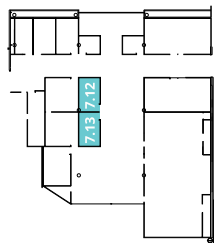

Room 7.12 and 7.13



24 sqm each

Room height: 3.00 m

Capacity: 14 pax each

-  Built-in floor box
-  4 X wall sockets
-  Power socket
-  Air conditioning unit
-  Ventilation grill



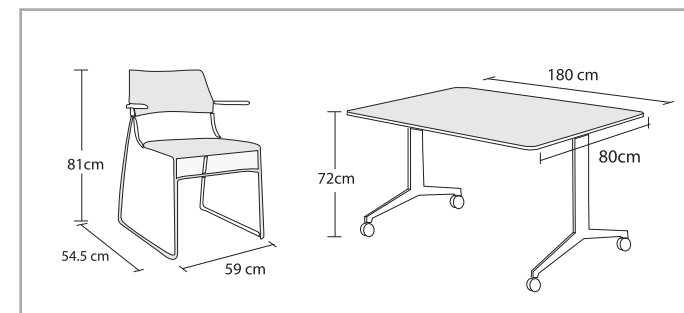
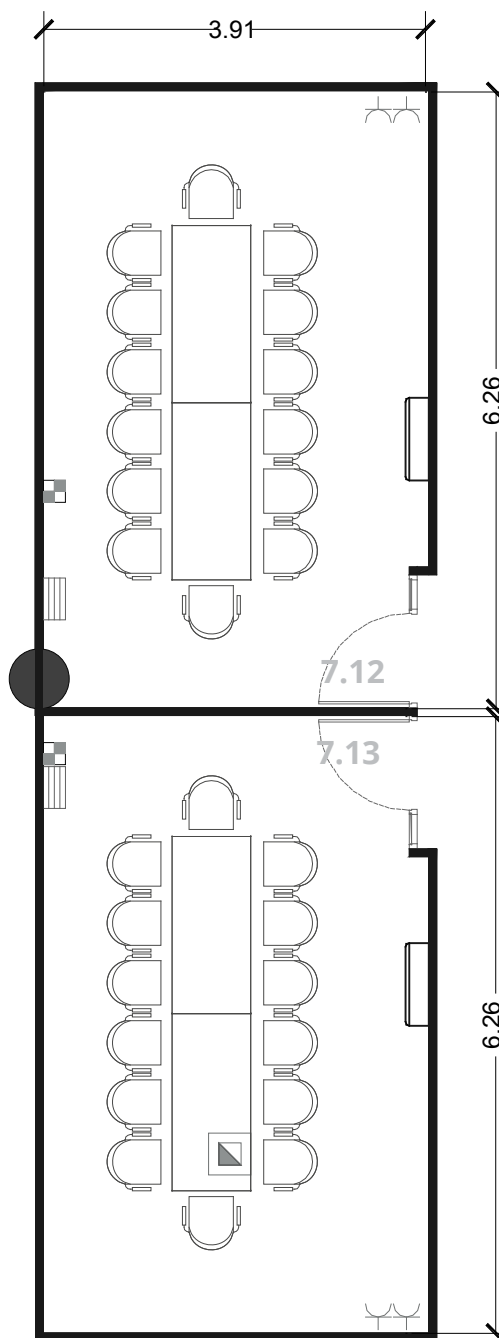

Room capacity: 14 pax each

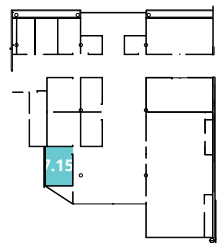

Room 7.15



35 sqm
Room height: 3.00 m

-  Built-in floor box
-  4 X wall sockets
-  Power socket
-  Air conditioning unit
-  Ventilation grill

Room capacity: 16 pax

