

Rooms 7.4 and 7.5









80 sqm (40 + 40sqm)





Room height: 3.00 m

Soundproof doors and walls

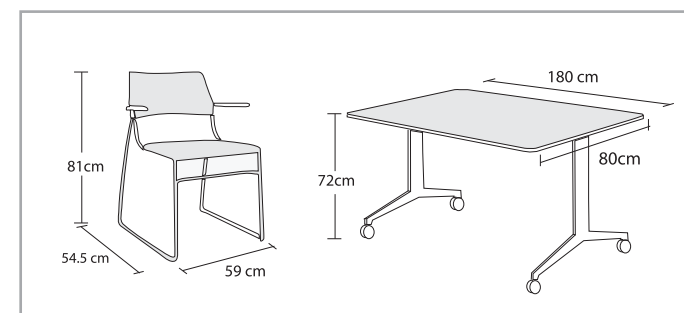
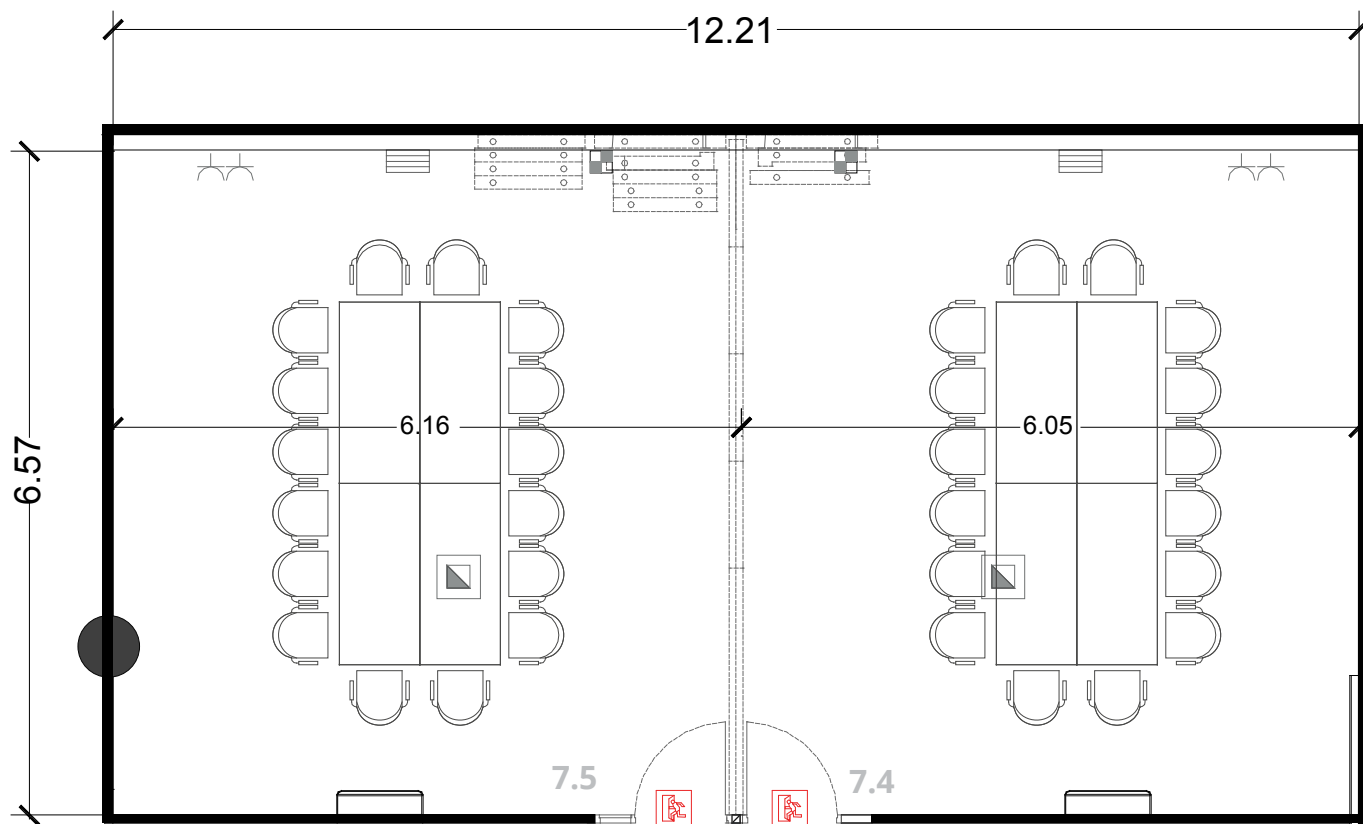
The room can be divided with airwalls

-  Emergency exit
-  Built-in floor box
-  4 X wall sockets
-  Power socket
-  Air conditioning unit
-  Ventilation grill



ROOM CAPACITIES				
				
	Theatre	Classroom	U shape	Boardroom
7.4 or 7.5	25	12	14	16
7.4 + 7.5	67	36	27	30

The default format is boardroom

7.4 or 7.5
7.4 + 7.5